



Matrix Back Interface

for the

Quantum Tru-Balance 3 Seating System

Installation Instructions



Important Symbols in this Manual

Setting up and operating your wheelchair safely depends on your own good judgement and common sense, as well as that of your provider, caregiver and/or health professional.

The safety symbols below are used throughout this manual to identify warnings, cautions and important notes. It is very important for you to read and understand them completely.

Safety Symbols:



WARNING!

This symbol warns you of danger!

- Always follow these instructions to avoid injury to the user or damage to the product!



IMPORTANT!

- Important information to remember when operating/installing your Motion Concepts product/device.



NOTE:

- This symbol identifies general information which is intended to simplify working with your product and/or which refers to special functions or important instructions.



Requirements:

- This symbol identifies a list of various tools, components and items which you will need in order to carry out certain work.



READ WELL BEFORE OPERATION!

- This symbol advises you to read information carefully.

Contact Information:

If you have any questions or require support concerning your Motion Concepts product/device, please contact your authorized Motion Concepts Dealer, who has the necessary training and equipment to meet your needs, or you may contact Motion Concepts directly for assistance. The more we are able to understand your needs, the better we will be able to meet them.

CANADA

Motion Concepts LP
84 Citation Drive, Unit 1
Concord, Ontario
L4K 3C1

Tel (local): 905-695-0134
Tel (toll free): 866-748-7943
Fax: 905 695 0138
Tech Service: 800-680-4191
@ info@motionconcepts.com
www. www.motionconcepts.com

USA

Motion Concepts
700 Ensminger Rd, Suite 112
Tonawanda, New York
14150

Tel.: 716-447-0050
Tel (toll free): 866-433-6818
Fax: 888-433-6834
Tech Service: 888-433-6818

1.0 SAFETY INFORMATION/WARNINGS



PLEASE READ ALL SAFETY INFORMATION THOROUGHLY BEFORE INSTALLATION!

1.1 General Safety Warnings!



IMPORTANT! Motion Concepts disclaims all responsibility and liability for any personal injury or damage to property that occurs as a result of improper or unsafe use or installation of the Matrx Back interface assembly, and/or any unauthorized dealer or third party repairs or modifications made to the Matrx Back interface.



IMPORTANT! Please be certain to read and follow the important safety warnings provided in your Power Base Owners/Operators Manual (*provided separately*).



WARNING! Danger of injury if wheelchair power positioning system and/or Matrx back is used in any other way than the purpose described!

- Only ever use the wheelchair/seating system in accordance with the instructions provided in this Manual and your Quantum (Pride Mobility) Wheelchair Owners/Operators Manual (*provided separately*)

1.2 Stability Warnings!

Only the dealer and the health care professional can ensure that the system meets your individual requirements. It is your dealer or healthcare professional's responsibility to ensure that the wheelchair and the power positioning system are set up properly and safely for your specific needs.



WARNING! By changing your seating position (tilting/ reclining/ elevating), you are changing the stability characteristics of the wheelchair.

- It is very important that the Matrx Back is set up so that it is stable in all seating positions.



WARNING! When evaluating stability, remember the following:

- Determine and establish your personal safety limits by practicing bending, reaching and transferring activities in the presence of a qualified healthcare professional before attempting active use of the wheelchair.
- Consider all personal gear and accessories (backpacks, vent systems, extra batteries, etc..) that will be carried on the wheelchair. For example, a loaded backpack, attached to the back of the seating system, can significantly reduce the rearward stability of your wheelchair.
- **Never** extend your arms backward beyond the back when the seating system is in a tilted or reclined position. This could shift your center of gravity enough to cause the wheelchair to become unstable.

1.3 Motor Vehicle Transportation Warnings!



WARNING! The Matrx Back Cushion in combination with the wheelchair base has NOT been crash tested and may NOT be used as a vehicle seat!

- Your Motion Concepts Matrx Back (in combination with the OEM wheelchair power base) has not been tested to the requirements of ISO 7176-19:2001 or ANSI/RESNA WC-19 and may not under any circumstances be used as a vehicle seat or to transport the user in a vehicle.
- Using a wheelchair that does not fulfill these criteria as a vehicle seat can lead to the most severe injuries and even death in the event of a traffic accident.



WARNING! When travelling in a motor vehicle you must be properly secured in a motor vehicle seat with safety belts securely fastened.

- Although your chair may be equipped with a positioning belt, this belt is not designed to provide proper restraint during motor vehicle transport. **DO NOT** sit in your wheelchair while it is in a moving vehicle.

1.0 SAFETY INFORMATION/WARNINGS

1.4 Weight Capacity

A variety of Matrix backs are available to interface onto the Quantum Tru-Balance 3 seating system, including Posture Backs (MPB), Elite Backs (PBE), Elite TR Backs (PBE-TR) and Elite Deep Backs (EDB). Back widths are limited to a range from 16"W (41cm) up to 20"W (51cm), with a maximum load/weight capacity of lb. (136kg) for each Matrix back model available.



WARNING! Danger of injury if maximum permissible load is exceeded!

• *Do not exceed the maximum permissible load/weight capacity of the Matrix Back or the wheelchair base (whichever is less)*



IMPORTANT! If you have any concerns or questions regarding weight capacities, or if the total occupant weight is determined to be greater than the maximum permissible load of the Matrix back, please contact our Technical Service Department immediately.

1.5 Flammability

The materials (foam and fabrics) utilized in our Motion Concepts seating products are tested to ensure compliance with North American Flammability Standards (California Technical Bulletin CA TB 117)



WARNING! Always exercise caution near open flames and cigarettes.

1.6 Hardware



WARNING! Do not substitute hardware

• *All hardware used by Motion Concepts in the assembly and installation of our products/devices is high strength. Use only the hardware supplied with the seating system.*

Should you require any replacement hardware for your seating system, please contact our Customer Service Department, or your local authorized Motion Concepts Dealer for assistance.

2.0 MATRIX INTERFACE KIT

2.1 Matrix Interface Kit Contents (for Quantum Tru-Balance 3)

***Note:** The Matrix Back Model may vary from image shown.

ITEM NO.	QTY.	PART NO.	DESCRIPTION
1	3	TRH0805	M6-1.0 x 15mm FLAT SOCKET CAP, 10.9 ALLOY STEEL, BZ
2	4	TRH0391	5/16-24 x 1 1/2" BUTTON SOCKET CAP, ALLOY STEEL, BZ
3	8	TRH0719	M6-1.0 x 12mm FLAT SOCKET CAP, 10.9 ALLOY STEEL, BZ
4	4	TRM0176	P210 SPACER WASHER
5	4	TRM0648-250	SPACER, 3/8" ID X 1" OD X 1/4" THK
6	4	TRM0648-500	SPACER, 3/8" ID X 1" OD X 1/2" LONG
7	1	TRX8540	Q6 EDGE MOUNT PLATE
8	1	TRX8853	UNIVERSAL MOUNT, LEFT
9	1	TRX8852	UNIVERSAL MOUNT, RIGHT
10	4	TRX7841	METRIC CLAMPING BAR
11	3	TRX8517	FLANGED MOUNT POST



Quantum Interface
(shown on Matrix Elite TR Back)

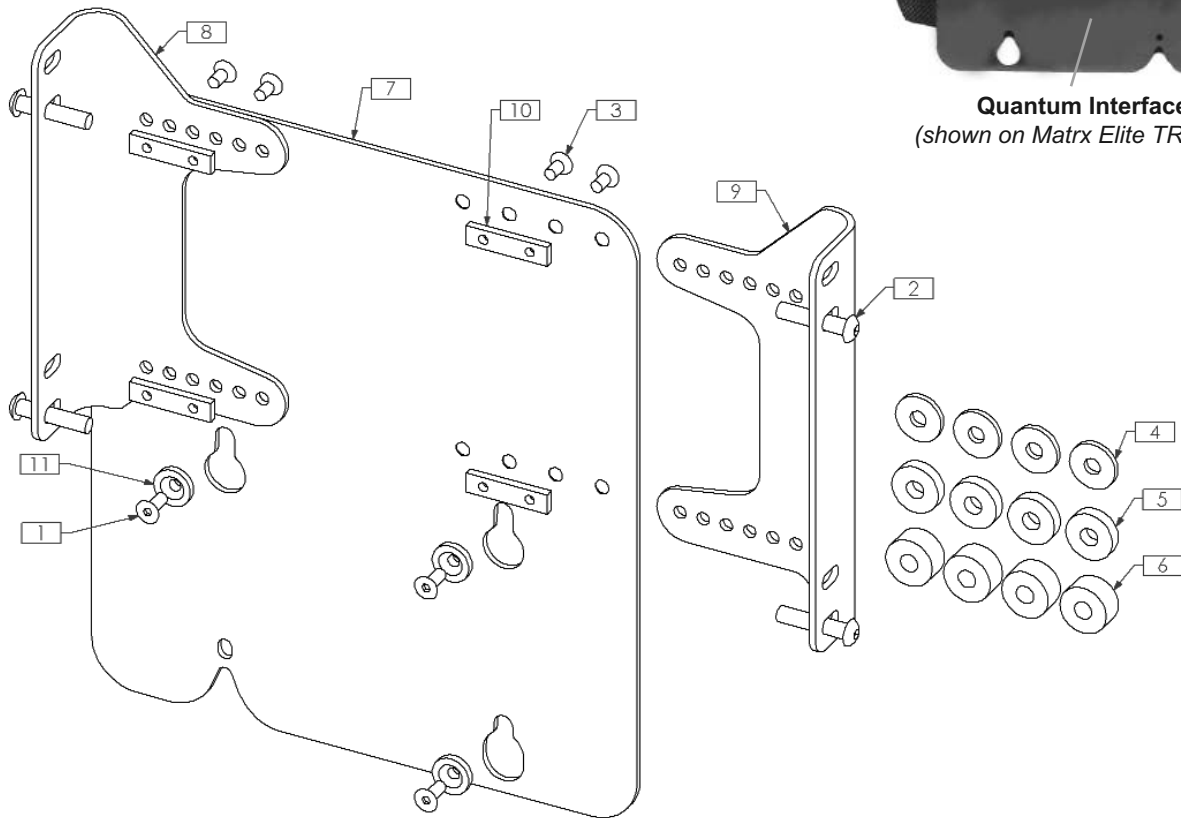

i Important! 3 different sizes (thicknesses) of spacers/washers are provided to address any dimensional variations b/w the universal mounting brackets and the back shell to which they are installed. Where necessary, install the most appropriate sized spacers/washers between the mounting brackets and the back shell to eliminate any gaps.

3.0 TOOLS REQUIRED FOR INSTALLATION



Wrenches: None

Allen Keys: 4 mm; 3/16"

4.0 INSTALLATION PROCEDURE

 **Some of the original mounting hardware is required to complete the Matrix Back installation.** Please read through the entire installation instruction prior to removing the original back shell.

4.1 Preparing the Quantum Seating System

4.1.1 Remove the outer cushion/cover from the OEM (Quantum) back shell.

4.1.2 Remove and retain the thumb knob* from the Quantum back shell (refer to image **A** below). If necessary, refer to the Pride Mobility/Quantum Wheelchair Owners Manual (*provided separately*) for further instructions on removing the existing back shell.

 **IMPORTANT!** *The original thumb knob must be retained in order to complete the Matrix back installation.

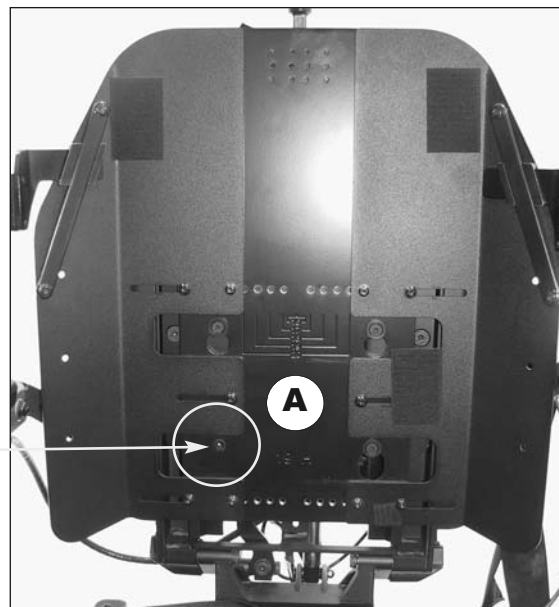
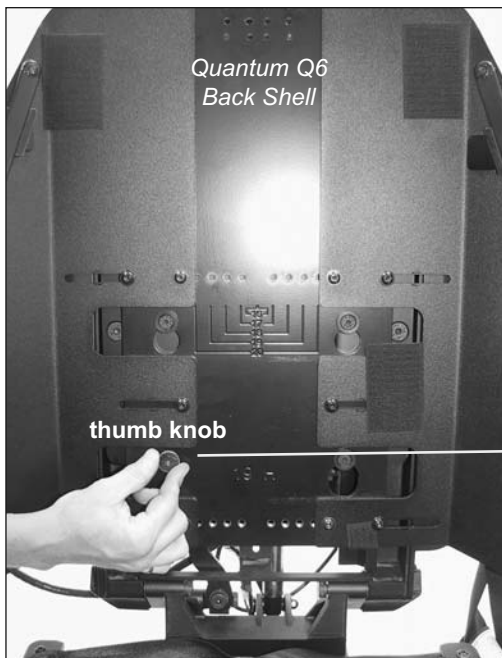

Remove and retain original thumb knob

4.1.3 With the thumb knob removed, carefully lift the entire Quantum back shell assembly straight upward to disengage it from the three (3) remaining mounting pins/posts (see images **B** and **C** below).

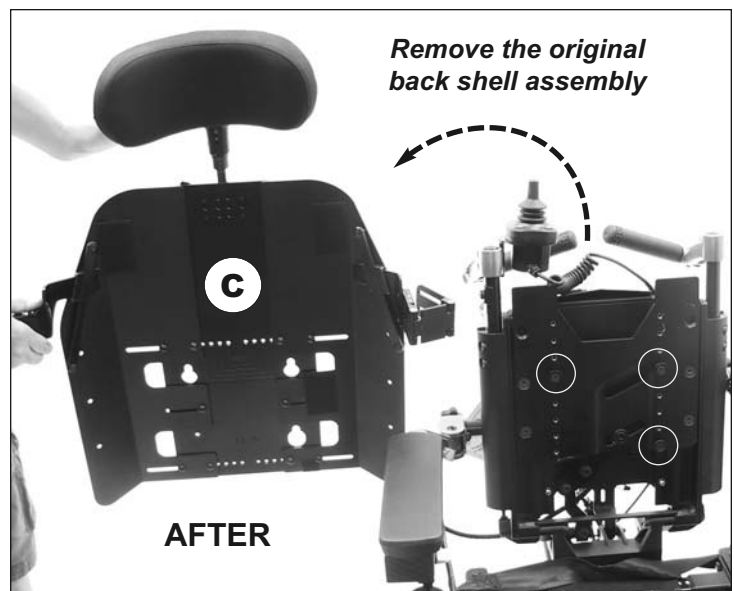
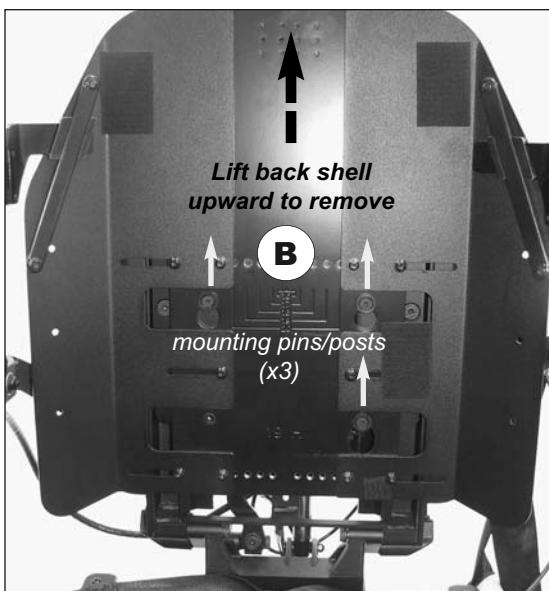

4.0 INSTALLATION PROCEDURE

4.1 Preparing the Pride Mobility/Quantum Wheelchair Base (...cont'd)

4.1.4 *Note:* The original mounting pins/posts (x3) on the Quantum recline plate must be replaced with the new longer mounting posts provided. Remove the three original mounting post assemblies (as indicated in image **D** below). The original mounting post hardware is no longer required.

4.1.5 Install the new flanged mounting post hardware (provided) into the same hole location as the original mounting posts. (See image **E** below). Ensure the mounting pin assemblies are fully tightened/secured.

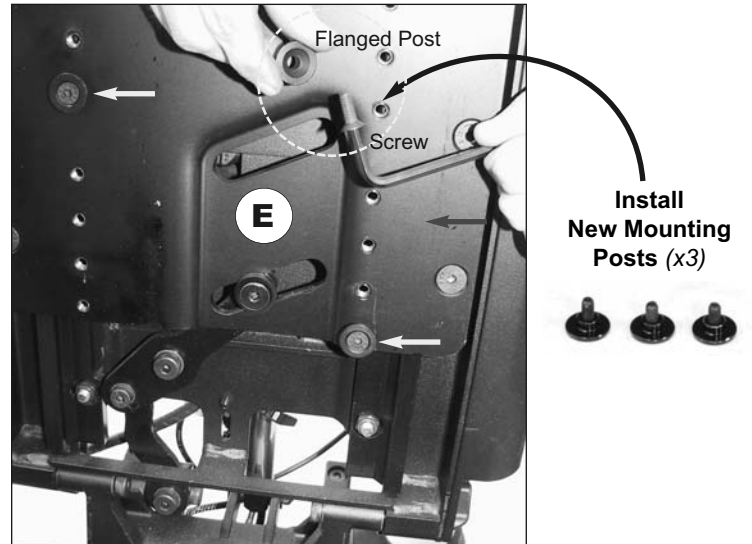
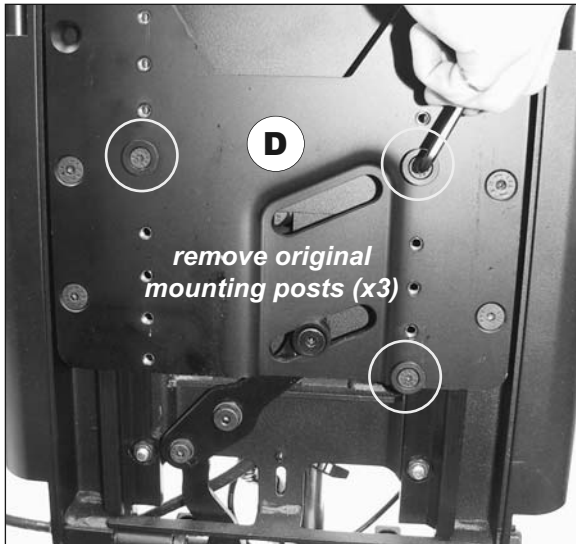

4.0 INSTALLATION PROCEDURE

4.2 Installing the Interface Plate onto the Matrix Back (*Matrix Elite* or *Matrix PB Back*)

i **NOTE:** When ordered together, the interface plate may be pre-installed onto the Matrix back at the factory. If your interface plate has been pre-installed onto the back shell, then please proceed to **Section 4.3**.

i **IMPORTANT! Before You Begin.** The final back height on the wheelchair is determined by the mounting position of the mounting brackets on the interface plate. Please review the images below prior to installing the mounting brackets. For most typical installations, the standard mounting bracket configuration will be suitable. If you require a lower back height on the wheelchair, then the inverted bracket configuration is recommended.

4.2.1 Determine the appropriate bracket orientation and install the mounting brackets onto the interface plate to match the width of the Matrix back being installed. Mounting brackets are adjustable from 16W - 20W. The narrowest (16W) configuration is illustrated below; For every 1" increase in back width, adjust each mounting bracket outward by 1/2". Install the mounting brackets using the hardware provided. (*Always use 4 screws per bracket*).

i. Interface Plate Assembly/Adjustment

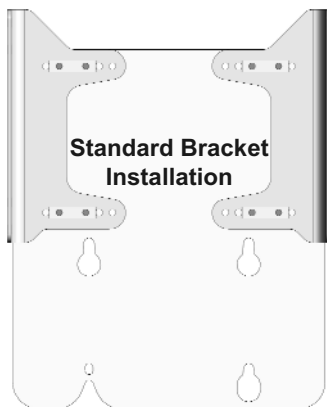
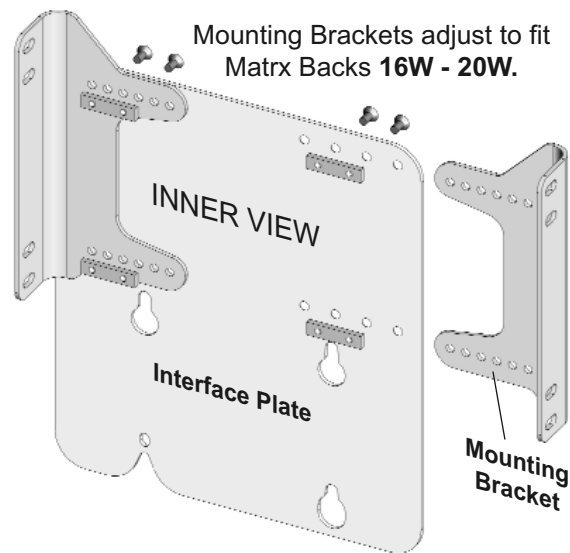
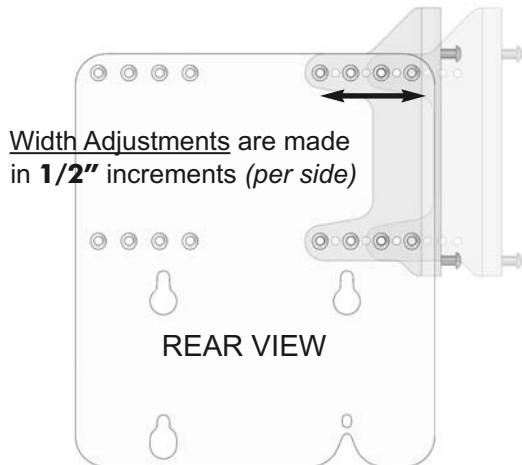

i *Inverting the mounting brackets will lower the overall back height (on the wheelchair) by an extra inch*

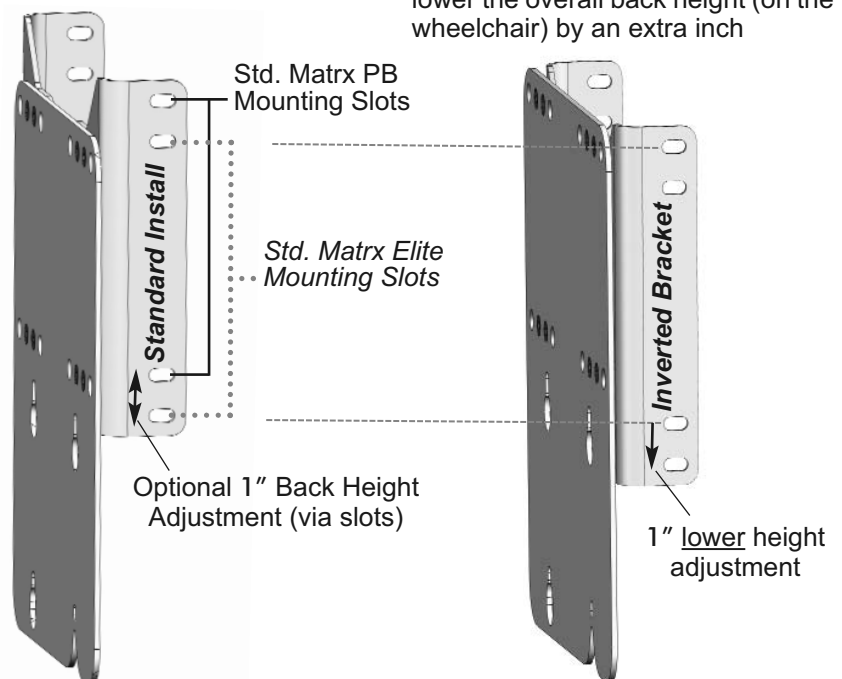

4.0 INSTALLATION PROCEDURE

4.2 Installing the Interface Plate Ass'y onto the Matrix Back (Matrix Elite or Matrix PB Back)

4.2.2 Align the interface assembly with the Matrix back. If there is a visible gap (1/8" or larger) between the mounting brackets and the back shell, install the appropriate sized spacer/washer at each of the pin locations to fill in the gap- see **Important!** note below.

4.2.3 Install/thread the four (4) mounting pins (*provided*) through the appropriate slots in the mounting brackets (*incl. spacers if applicable*). For typical slot/pin locations, refer to the sample configurations illustrated below.

4.2.4 Ensure each of the mounting pins is fully tightened/secured into the back shell.

i **IMPORTANT!** 3 different sizes (thicknesses) of spacers/washers are provided to address minor dimensional variations b/w the mounting brackets and the back shell to which they are installed. When necessary, install the appropriate sized spacers/washers between the mounting brackets and the back shell.

i. Matrix PB Back Interface Assembly

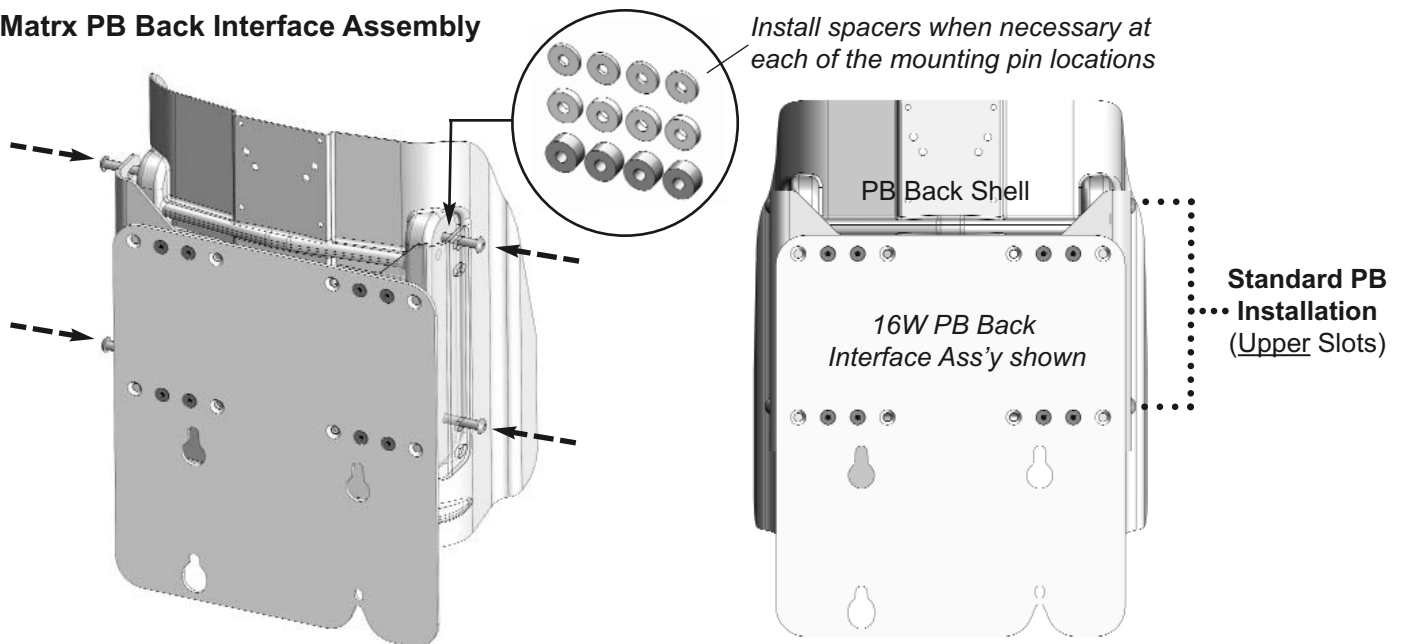

ii. Matrix Elite Back Interface Assembly

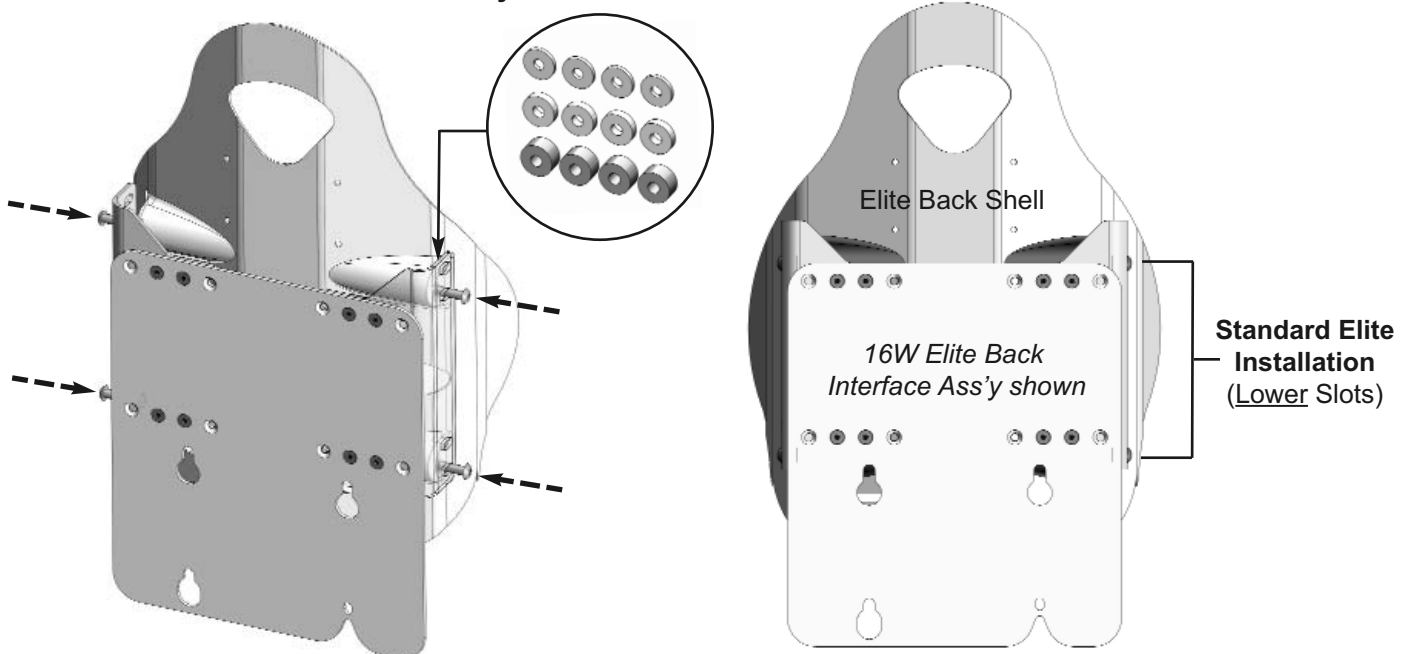

4.0 INSTALLATION PROCEDURE

4.3 Installing the Matrix Back (Interface Plate) on the Quantum Wheelchair

i PLEASE NOTE: For illustration purposes, the Matrix Back cushion/shell is not shown.

4.3.1 Align the three (3) slots on the interface plate assembly with the three (3) newly installed mounting pins on the Quantum recline support plate (refer to image **F** below). Ensure that the interface plate is flat against the recline support plate and push/slide the Matrix back assembly (interface plate) firmly downward so that it is fully seated onto the mounting pins.

4.3.2 Inspect the interface plate to ensure that all three (3) mounting posts are properly engaged. Verify that the threaded thumb knob hole is visible through the interface plate. If the hole is not visible/aligned, repeat Step 4.3.1.

4.3.3 Re-install the original thumb knob into the threaded thumb knob hole through the interface plate (refer to image **G** below). **Note:** the original thumb knob was removed in **Section 4.1 (4.1.2)**

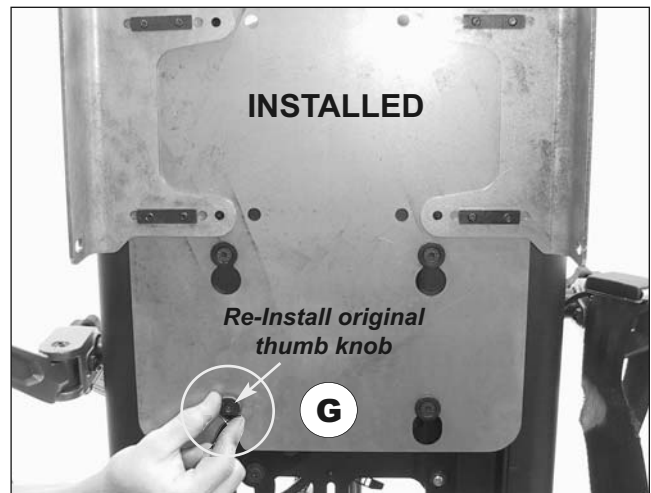
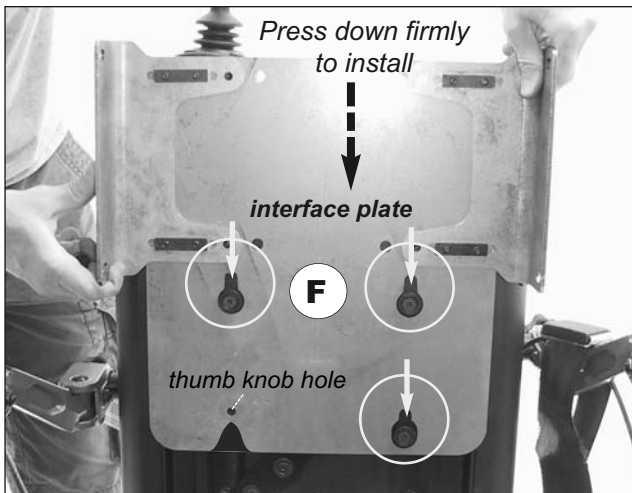

! WARNING! Risk of injury

The original thumb knob must be re-installed to lock the back in place on the wheelchair. Failure to do so could cause the back to disengage from the mounting posts resulting in serious personal injury.



If you have any concerns or questions regarding the Matrix Back Interface Installation, please contact our Technical Service Department for assistance.

USA: 888-433-6818 CAN: 800-680-4191

NOTES:

CANADA

Motion Concepts LP
84 Citation Drive, Unit 1-7
Concord, Ontario
L4K 3C1

Tel (local): 905-695-0134
Tel (toll free): 866-748-7943
Fax: 905 695 0138
Tech Service: 800-680-4191
@ info@motionconcepts.com
www. www.motionconcepts.com

USA

Motion Concepts
700 Ensminger Rd, Suite 112
Tonawanda, New York
14150

Tel (local): 716-447-0050
Tel (toll free): 866-433-6818
Fax: 888-433-6834
Tech Service: 888-433-6818